

MINIATURE MICROSWITCHES - POSITIVE BREAK

831607

- › Coil spring snap-action mechanism with wiping contacts
- › Positive opening action according to IEC 60947-5-1 Annex K
- › Ratings from 10 mA 4 V_{DC} to 6 A 250 V_{AC}
- › Very long life
- › Extended range of terminals
- › cURus approved
- › Choice of actuators: stainless steel or plastic

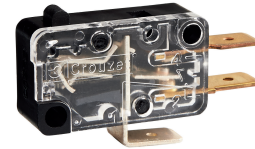

Main specifications

Positive break	
831607	
Standard	Dual-current (DORE)
83160702	83160796
83160704	83160786
83160706	●
●	●
●	●
83160708	●
83160701	83160794
83160703	83160797
83160705	●
●	●
83160707	●

Function	Connections
I (changeover)	W2
I (changeover)	W3
I (changeover)	W6A5
I (changeover)	X1
I (changeover)	X2
I (changeover)	X3
R (normally closed)	W2
R (normally closed)	W3
R (normally closed)	W6A5
R (normally closed)	X2
R (normally closed)	X3

Electrical characteristics

Positive opening action

Rating nominal / 250 V _{AC} (A)	6	6*
Thermal current (I _{th}) A	10	10
Mechanical characteristics		
Maximum operating force (N)	4	
Min. Release force (N)	1.5	
Minimum positive opening force (N)	18	
Max. Allowable overtravel force (N)	200	
Rest position max. (mm)	15.7	
Operating position (mm)	14.8 ^{±0.3}	
Positive opening position (mm)	13.5	
Maximum differential travel (mm)	0.3	
Min. overtravel (mm)	1.3	
Ambient operating temperature (°C)	-40 → +85	
Mechanical life (operations)	10 ⁷	
Contact gap (mm)	1.2	
Weight (g)	7	

Additional specifications

- Case, Button: PBT GF (UL 94-V0 / GWFI 960 °C)
- Cover: PC (UL 94-V0 / GWFI 850 °C), transparent
- Contacts: silver alloy, gold-plated silver alloy (dual-current)
- Terminals: brass (except W2/X: copper nickel), silver plated common
- Levers: stainless steel or polyamide, polyamide roller
- Degree of protection: IP40 (mechanism)
- Recommended actuating speed: 0.1 mm/s to 0.5 m/s
- Rated insulation voltage U_i: 250 V
- Impulse withstand voltage U_{imp}: 4 kV

Product adaptations



- › Special levers : special shapes and lengths
- › Special connections : angled, screw with clamp (W5), full wiring with custom connector....
- › Adjustable fixing by metal threaded barrel (SP9627)
- › Variant for irradiated environment

Standard product

Product made to order



Contact us

Principles

Single break snap-action switch with positive opening action on NC contacts (1-2) according to IEC 60947-5-1 Annex K

Changeover - SPDT (form C)

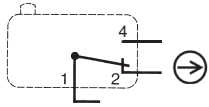

Normally closed - SPST-NC (form B)

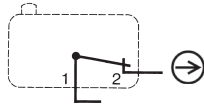

Curves

Electrical life

- Resistive load: 250 V \sim 6 A: 10⁵ cycles
- Inductive load (IEC 60947-5-1) : AC15: 250 V \sim 6 A: 0.3 x 10⁵ cycles
 DC13: 24 V --- 20 W L/R = 40 ms: 3 x 10⁵ cycles
 120 V --- 20 W L/R = 40 ms: 5 x 10⁵ cycles

* Dual-current models are designed to operate equally well on low current (10 mA 4 V minimum recommended) or medium-current (6 A maximum) circuits. However, a given product should only be used to switch one type of circuit during its working life

Dimensions

Product

831607

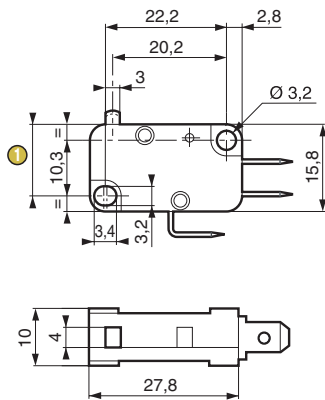

① Total travel position = 13.2 max.

Connections

W2 solder

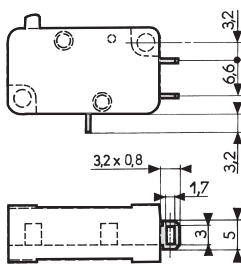

W3 quick-connect 6.3 x 0.8

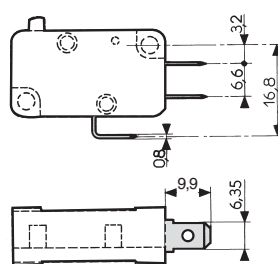

W6 quick-connect 4.8x0.5

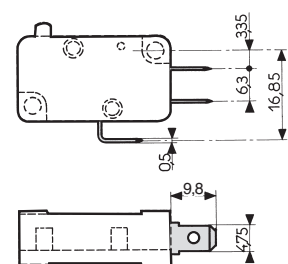

X1 for PCB, straight output

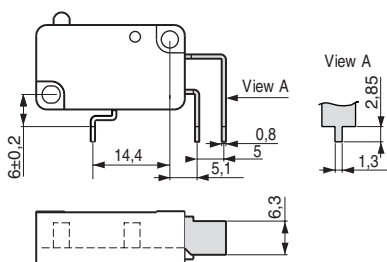

X2 for PCB, rear output

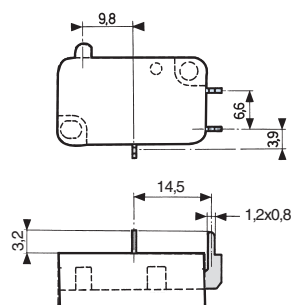

X3 for PCB, front output

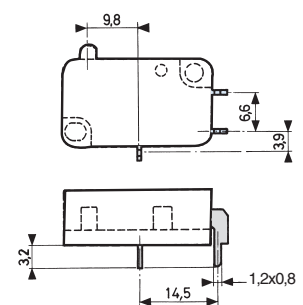

Actuator mounting positions

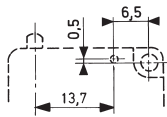

Actuators

139AX flat

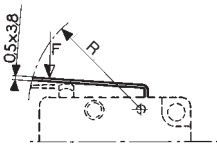

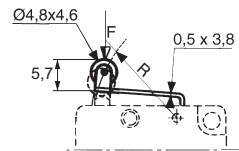

139EX roller

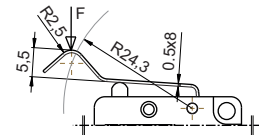

153FX dummy roller

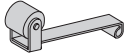

Actuator and mounting accessories

Actuators	Flat 139AX R16.2	Roller 139EX R15.8	Dummy roller 153FX R24.3
			
Operating force - max.	N	4	4
Release force - min.	N	1	1
Min. positive opening force	N	18	18
Maximum rest position	mm	16.2	21.3
Operating position	mm	15.3 ±0.3	20.5 ±0.45
Positive opening position	mm	14	19.2
Maximum total travel position	mm	13.9	19.1
We recommend that levers are assembled in our factories			

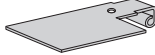
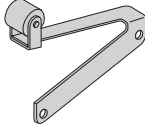
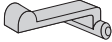
Actuators	Two-pole 139A2X R 24**	Flexible with roller 153B **	Plastic 153V **
			
** Consult us			

831607 microswitches with referenced actuators

Actuator	139AX R16.2	139EX R15.8	153FX R24.3	
831607 Standard	I W2	●	83160789	
	I W3	●	83160710	
	I X3	●	●	
	R W2	●	83160787	
	R W3	●	83160711	83160713
	R X3	●	83160714	●

Installation recommendations

See "Basic technical concepts"

How to order

Use the 8 digit part numbers when they are defined

Other cases, precise: Type of microswitch - Function - Connection - Actuator* - Adaptation*

* if needed

Example: 831607 DORE R W3 139AX R16.2

Standard product

Product made to order



Contact us

Examples of special adaptations

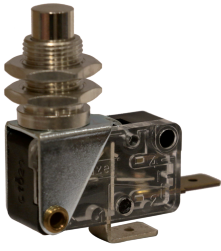

Metal plunger and threaded barrel for heavy duty and precise setting (SP9627)

MINIATURE MICROSWITCHES - POSITIVE BREAK

832607

- › Coil spring snap-action mechanism with wiping contacts
- › Positive opening action according to IEC 60947-5-1 Annex K
- › 6 A 250 V~ max rating
- › Operating temperature -40 °C to 125 °C
- › Very long life
- › Extended range of terminals - Stainless steel actuators
- › cURus and CCC approved



Main specifications

Main specifications		Positive break 832607
Function	Connections	
I (changeover)	W2	83260702
I (changeover)	W3	83260704
I (changeover)	W6	83260706
I (changeover)	W5	●
I (changeover)	X1	83260765
I (changeover)	X2	83260768
I (changeover)	X3	83260708
R (normally closed)	W2	83260701
R (normally closed)	W3	83260703
R (normally closed)	W6	83260705
R (normally closed)	W5	●
R (normally closed)	X2	83260732
R (normally closed)	X3	83260707
Electrical characteristics		
Positive opening action		→
Rating nominal / 250 V~ (A)		6
Thermal current (Ith) A		10
Mechanical characteristics		
Maximum operating force (N)		4
Min. Release force (N)		1.5
Minimum positive opening force (N)		18
Max. Allowable overtravel force (N)		200
Rest position max. (mm)		15.7
Operating position (mm)		14.8±0.3
Positive opening position (mm)		13.5
Maximum differential travel (mm)		0.3
Min. overtravel (mm)		1.3
Ambient operating temperature (°C)		-40 → +125
Mechanical life (operations)		10 ⁷
Contact gap (mm)		1.2
Weight (g)		7

Additional specifications

- Case: PET GF (UL 94-V0 / GWFI 960 °C / GWIT 775 °C)
- Button: PA66 GF (UL 94-V0 / GWFI 960 °C)
- Contacts: silver alloy
- Terminals: brass (except W2/X: copper nickel), silver plated common
- Levers: stainless steel, polyamide roller
- Degree of protection: IP40 (mechanism)
- Recommended actuating speed: 0.25 mm/s to 0.5 m/s
- Rated insulation voltage Ui: 250 V
- Impulse withstand voltage Uimp: 4 kV

Product adaptations



- › Special levers: special shapes and lengths
- › Lever mounted on position A for higher ratio
- › Special connections: angled, full wiring with custom connector....

Standard product

Product made to order

● Contact us

Principles

Single break snap-action switch with positive opening action on NC contacts (1-2) according to IEC 60947-5-1 Annex K
 Changeover - SPDT (form C) Normally closed - SPST-NC (form B)

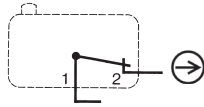
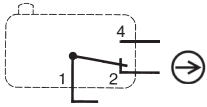

Curves

Electrical life

- Resistive load: 250 V \sim 6 A: 10^5 cycles
- Inductive load (IEC 60947-5-1): AC15: 250 V \sim 6 A: 0.3×10^5 cycles
 DC13: 24 V --- 20 W L/R = 40 ms: 3×10^5 cycles
 120 V --- 20W L/R = 40 ms: 5×10^5 cycles

Dimensions

Product

832607

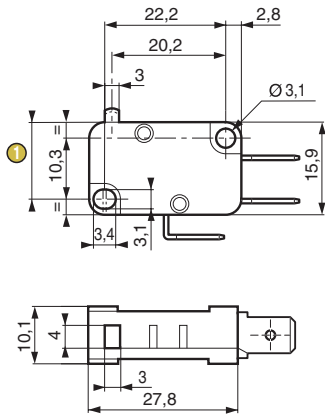

① Total travel position = 13.2 max.

Connections

W2 solder

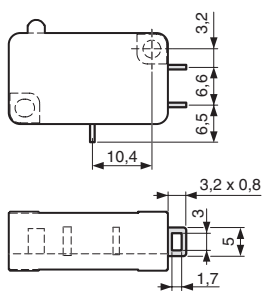

W3 quick-connect 6.3 x 0.8

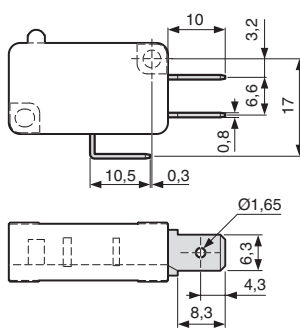

W5 screw with clamp

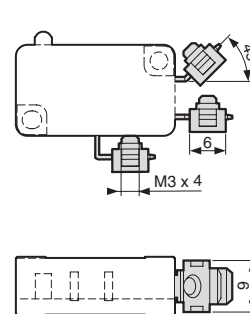

W6 quick-connect 4.8x0.5

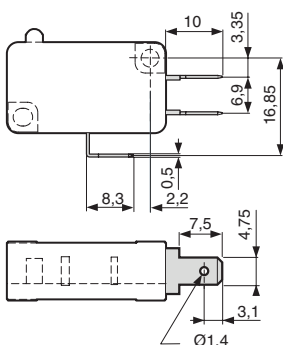

X1 for PCB, straight output

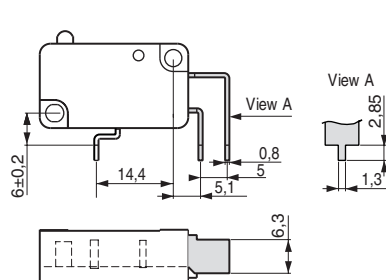

X2 for PCB, rear output

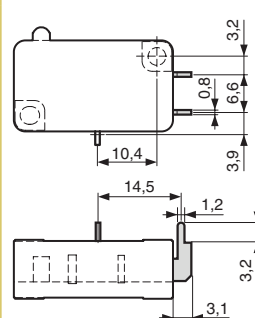

X3 for PCB, front output

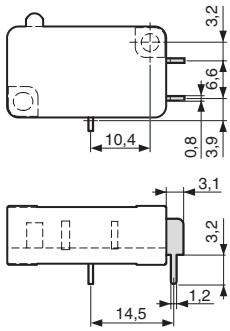

Actuator mounting positions

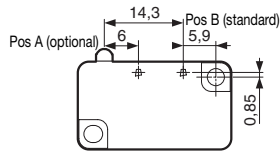

Actuators

260A flat

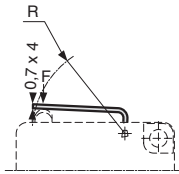

260E roller

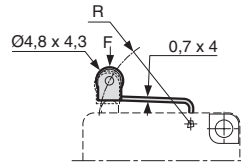

Other shapes and dimensions: consult us

Actuator and mounting accessories

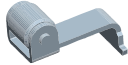
Actuators		Flat 260A R16.8	Roller 260E R16
			
Operating force - max.	N	4	4
Release force - min.	N	1	1
Min. positive opening force	N	18	18
Maximum rest position	mm	16.4	21.5
Operating position	mm	15.5 ±0.3	20.6 ±0.45
Positive opening position	mm	14.2	19.3
Maximum total travel position	mm	14.1	19.2

Levers are assembled in our factories

832607 microswitches with referenced actuators

	Actuator	260A R16.8 Pos B	206E R16 Pos B
832607	I W2	●	83260735
	I W3	●	83260710
	I W5	●	83260764
	I X3	●	83260736
	R W2	●	83260734
	R W3	●	83260711
	R W5	●	●
	R X3	●	83260714

Installation recommendations

See "Basic technical concepts"

How to order

Use the 8 digit part numbers when they are defined

Other cases, precise: Type of microswitch - Function - Connection - Actuator* - Fixing position*

* if needed

Example: 832607 R W2 260A R16.8 B

Standard product

Product made to order



Contact us